



# LEAGUE of LEGENDS

## 브론즈에게 희망을

LoL api를 이용한 유저 데이터 분석



201714167 양현영



201714168 유호원



201714169 조영래

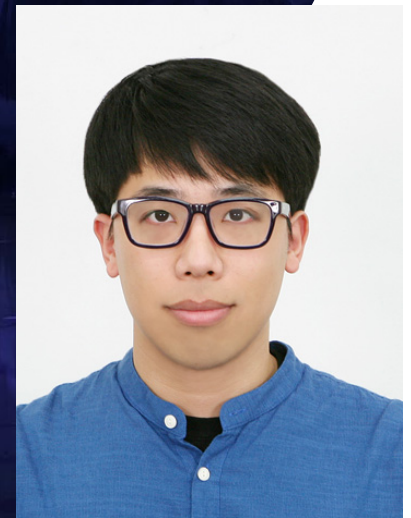

201714170 조해성

# Architecture Design

Architecture Diagram

High-Level Design

Low-Level Design

Traceability Matrix

KUGG

Data Analysis Module

소환사 전적 report

오브젝트 예측 모델

아이템트리 모델

소환사 분석 모델

챔피언 정보 분석 report

Web(Django Framework-Template)

챔피언분석

소환사 검색

소환사 상세 분석

오브젝트 분석

UI

Data Server



데이터 다운로드 모듈

Riot LoL API



# High-Level Design

첫번째 오브젝트 승률 예측 시퀀스 다이어그램

Architecture  
Diagram

High-Level  
Design

Low-Level  
Design

Traceability  
Matrix

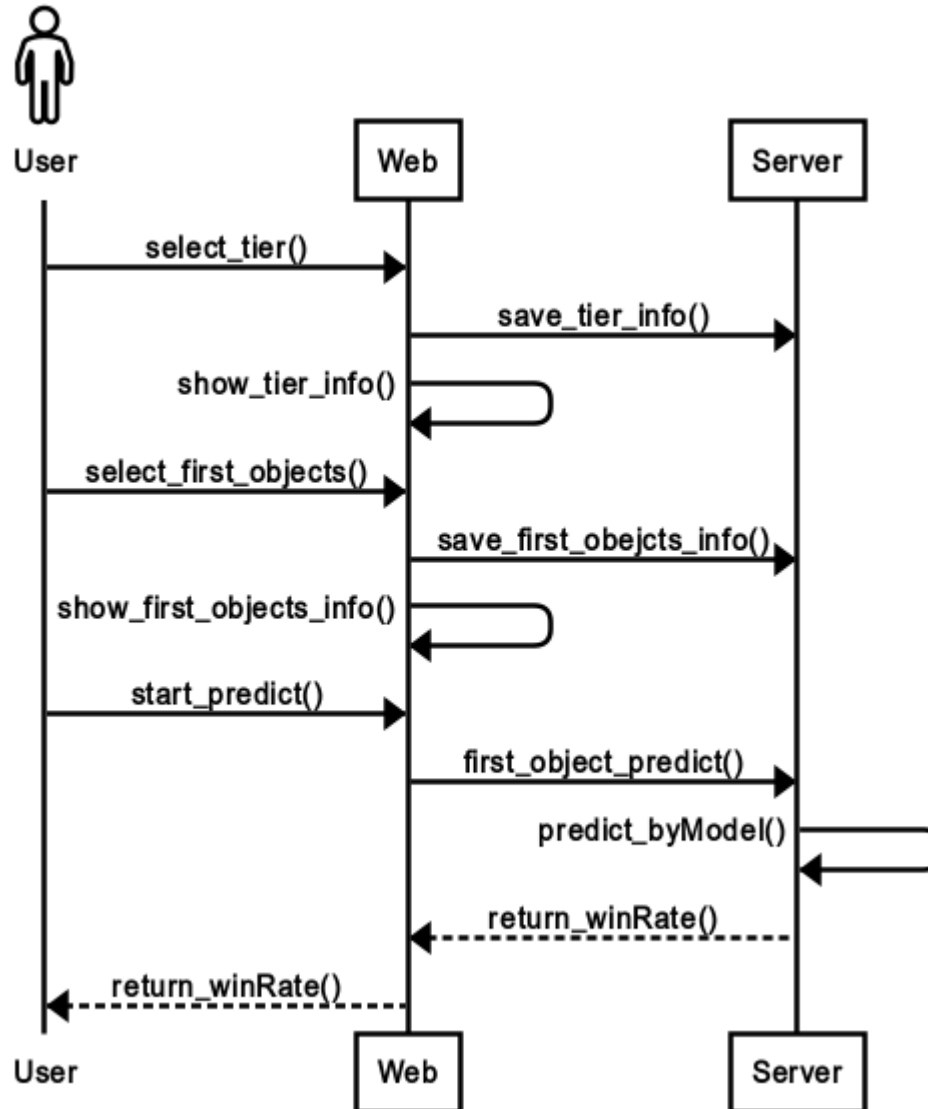

# High-Level Design

## 챔피언 분석 요청 시퀀스 다이어그램

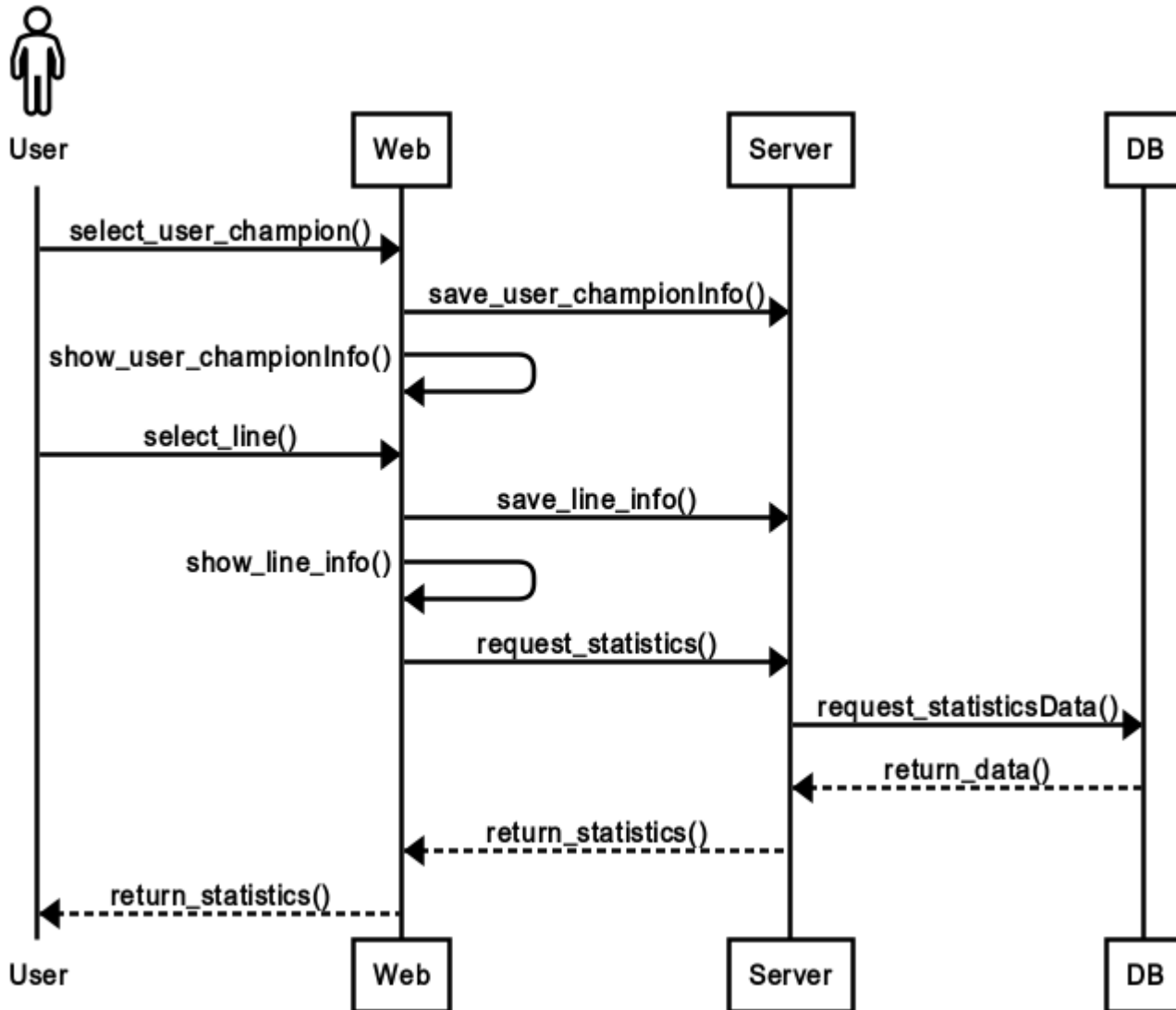

Architecture  
Diagram

High-Level  
Design

Low-Level  
Design

Traceability  
Matrix

# High-Level Design

데이터 다운로드 시퀀스 다이어그램

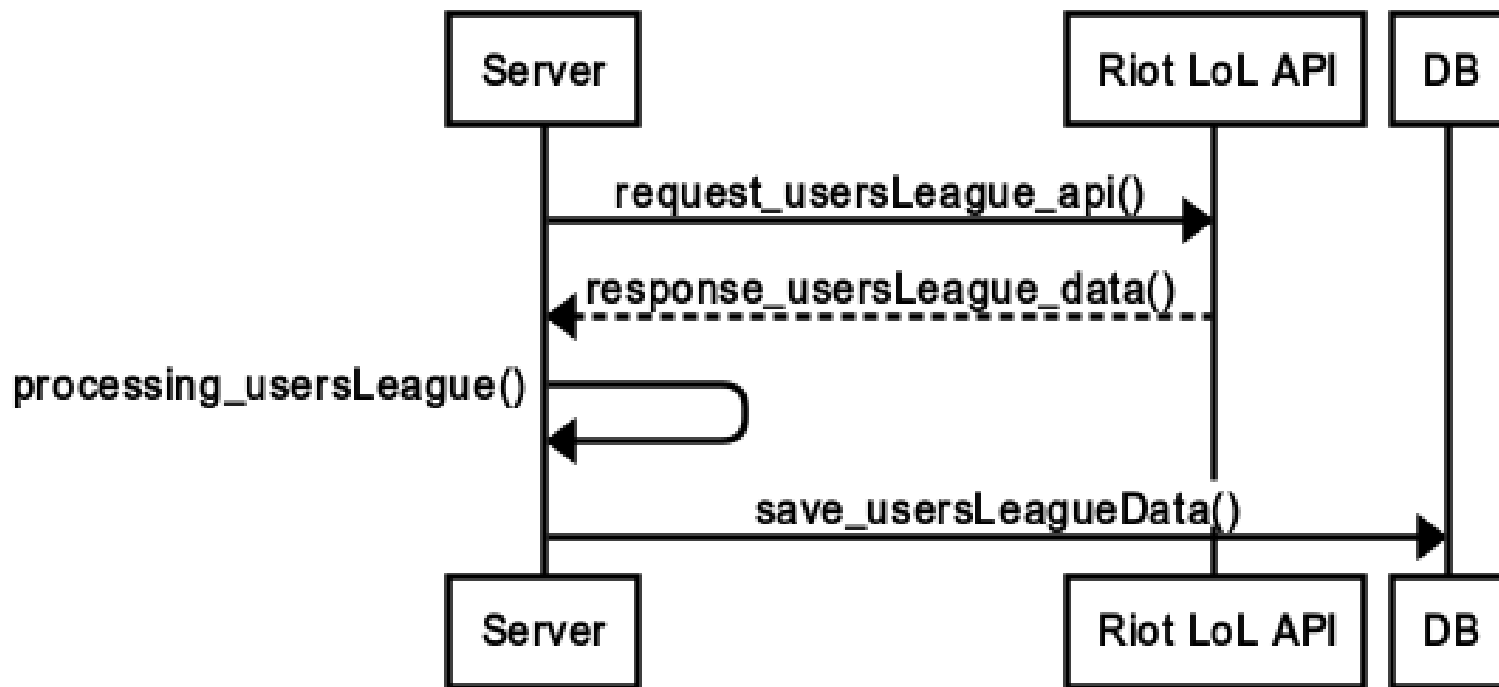

Architecture  
Diagram

High-Level  
Design

Low-Level  
Design

Traceability  
Matrix

# Low-Level Design

Architecture  
Diagram

High-Level  
Design

Low-Level  
Design

Traceability  
Matrix

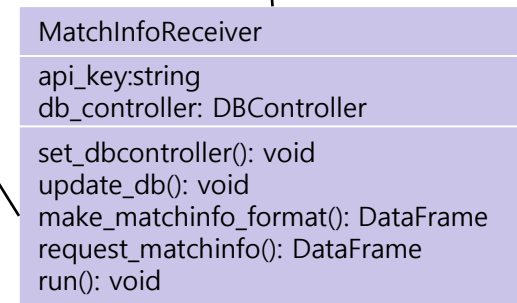
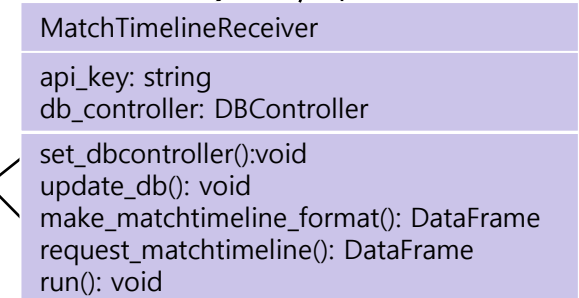
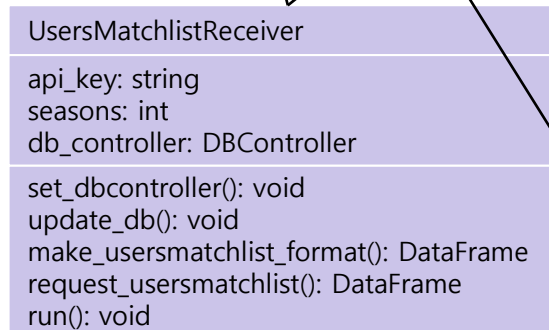
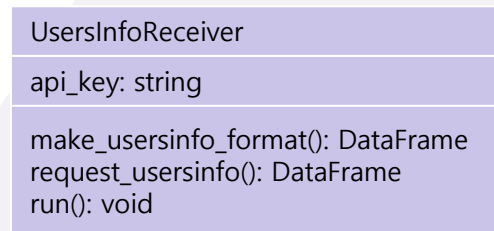
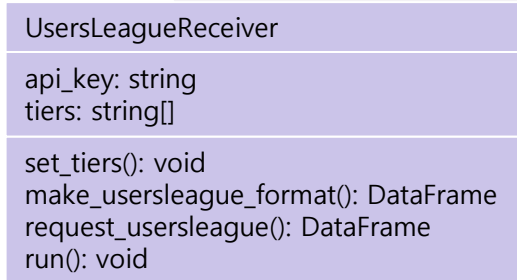
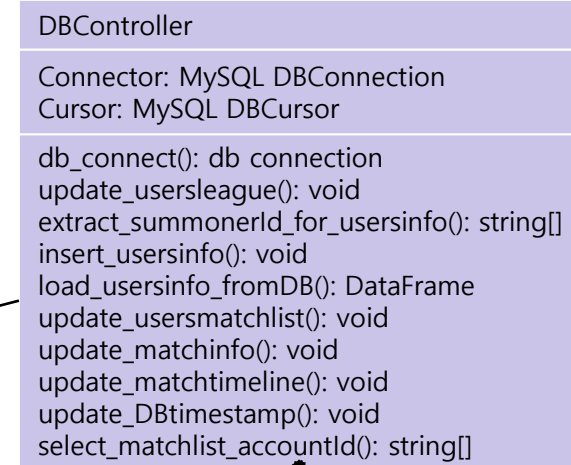
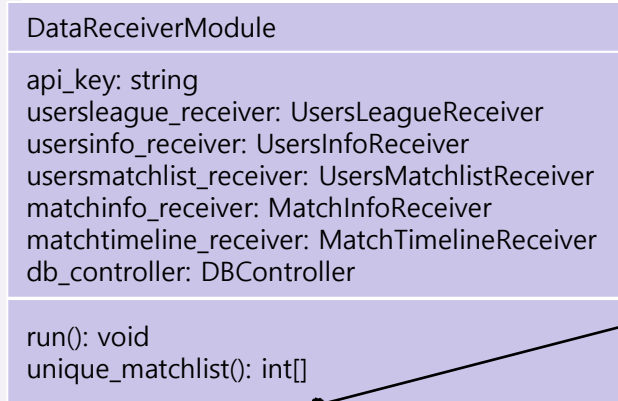

# Low-Level Design

Architecture  
Diagram

High-Level  
Design

Low-Level  
Design

Traceability  
Matrix

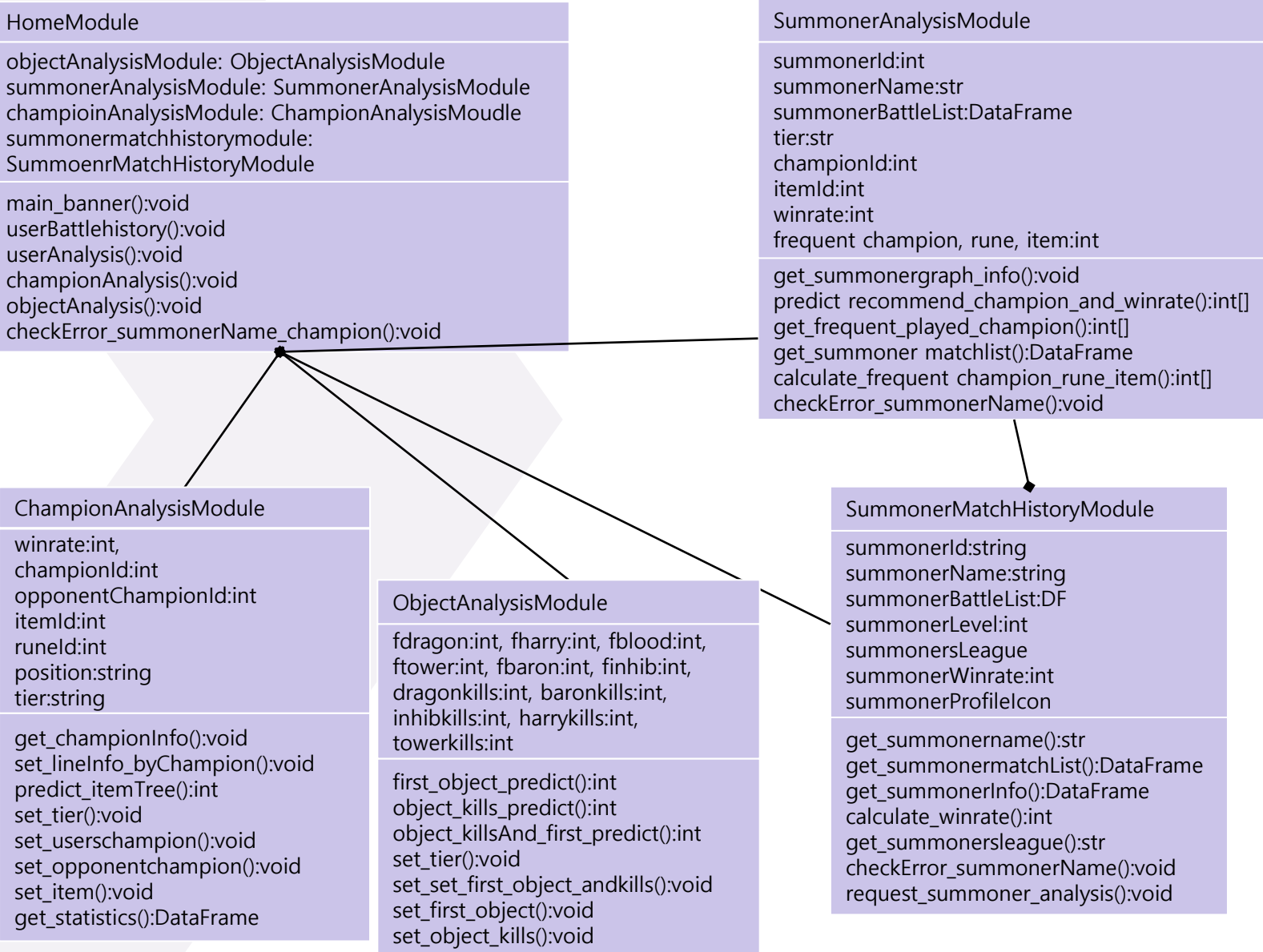

# Traceability Matrix

Architecture Diagram

High-Level Design

Low-Level Design

Traceability Matrix

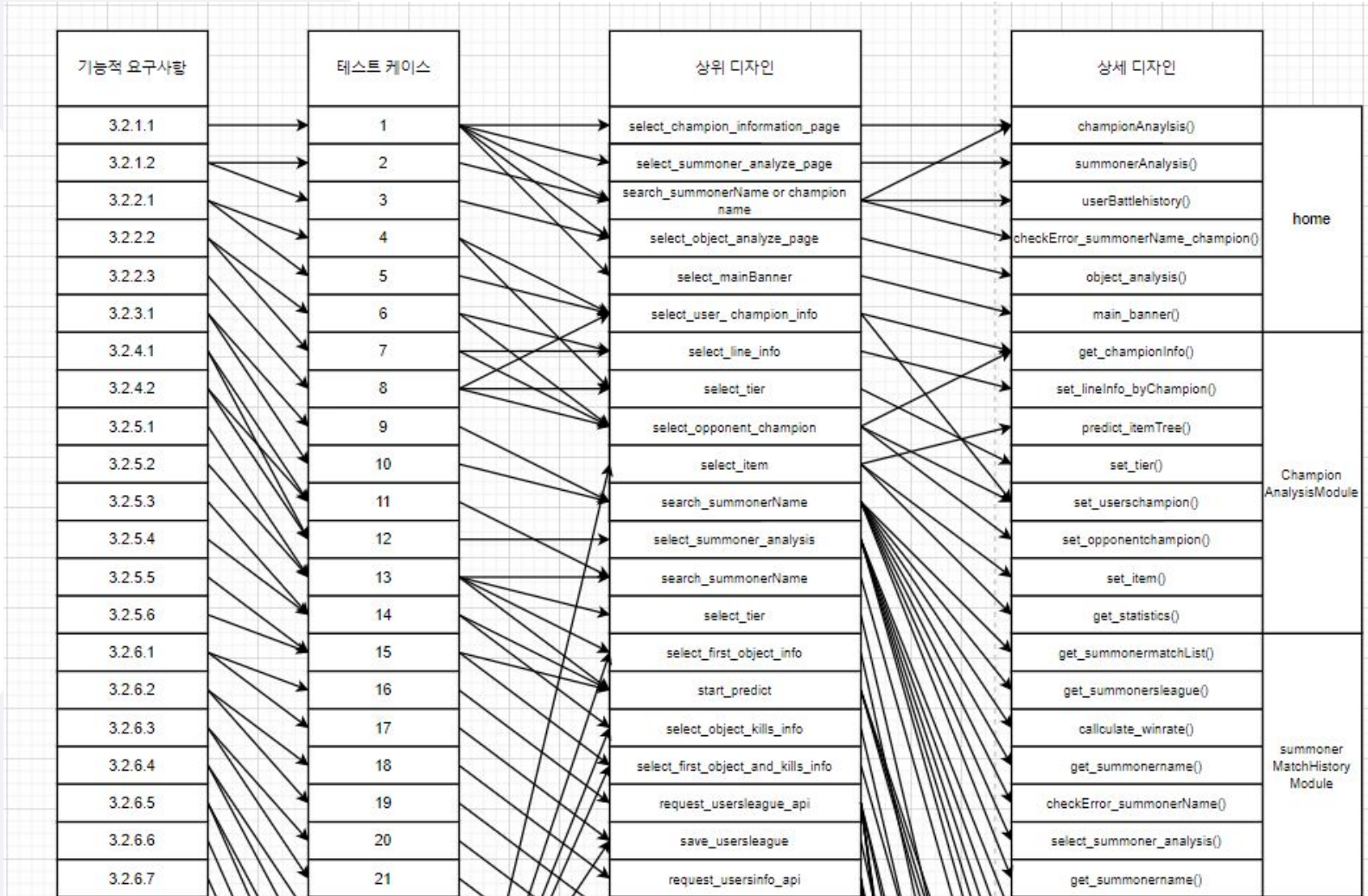



# Traceability Matrix

Architecture Diagram

High-Level Design

Low-Level Design

Traceability Matrix

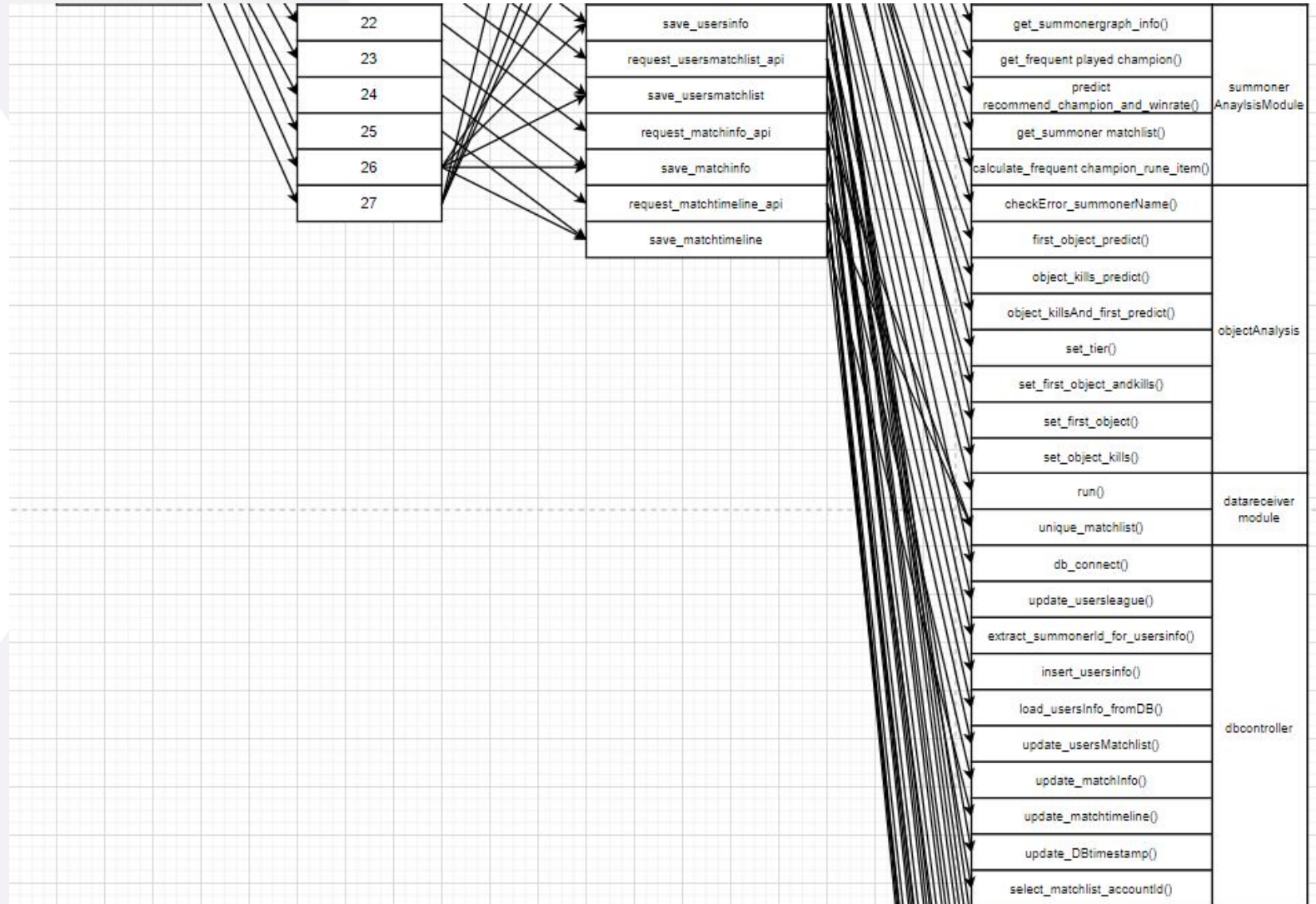

# Traceability Matrix

Architecture  
Diagram

High-Level  
Design

Low-Level  
Design

Traceability  
Matrix

